

IT2100F



SMD Temperature Compensated Crystal Oscillators

SMD TCXO using analogue ASIC for compensation and an optional Enable/Disable pin for efficient power management.

Product description

The I(V)T2100F employs an analogue ASIC for the oscillator and a high order temperature compensation circuit in a 2.0 x 1.6 mm size package. The device can be placed in power down mode through a single input pin. During standard operation, power consumption is minimized by operating down to a supply voltage of 1.8V. The I(V)T2100F's high stability, low power consumption, small footprint and powerful compensation method makes it a TCXO ideally suited for demanding GPS mobile applications.

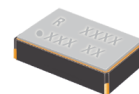

Applications

- Communications
- Consumer Products
- GPS
- LBS Handset
- PND
- Smartphone
- WiFi
- WiMAX/WLAN
- Other

Features

- Excellent phase noise performance
- Low Start-up drift rate
- Height less than 0.8mm
- Operates at 1.8V supply
- Power Down Mode
- Standard temperature stability of ± 0.5 ppm over wide temperature ranges

Specifications

1.0 SPECIFICATION REFERENCES

Line	Parameter	Description
1.1	Model description	IT2100F / IVT2100F / IT2100FP
1.2	RoHS compliant	Yes

2.0 FREQUENCY CHARACTERISTICS

Line	Parameter	Test Condition	Value	Unit
2.1	Frequency	Frequency range available	13 to 52	MHz
2.2	Frequency calibration	Offset from nominal frequency measured at 25°C $\pm 2^\circ\text{C}$	± 1 max	ppm
2.3	Reflow shift	Two consecutive reflows as per attached profile after 1 hour relaxation at 25°C	± 1 max	ppm
2.4	Frequency stability over temperature	Referenced to the midpoint between minimum and maximum frequency value over the specified temperature range. Control voltage set to midpont of control voltage (Note 1)	± 0.5 to 2	ppm
2.5	Temperature range	The operating temperature range over which the frequency stability is measured (Note 2)	-30 to 85	$^\circ\text{C}$
2.6	Frequency slope	Minimum of 1 frequency reading every 2°C over the operating temperature range (Note 1)	0.05 to 1	ppm/ $^\circ\text{C}$
2.7	Static temperature hysteresis	Frequency change after reciprocal temperature ramped over the operating range. Frequency measured before and after at 25°C	0.6 max	ppm
2.8	Sensitivity to supply voltage variations	Supply voltage varied $\pm 5\%$ at 25°C	± 0.1 max	ppm
2.9	Sensitivity to load variations	$\pm 10\%$ load change at 25°C (Note 3)	± 0.2 max	ppm
2.10	Long term stability	Frequency drift over 1 year at 25°C	± 1 max	ppm

3.0 POWER SUPPLY

Line	Parameter	Test Condition	Value	Unit
3.1	Supply voltage	Nominal supply voltage range	1.8 to 3	V
3.2	Current	At maximum supply voltage (Note 3)	2.2 max	mA

4.0 CONTROL VOLTAGE (VCO) OPTION

Line	Parameter	Test Condition	Value	Unit
4.1	Control voltage range Mode 1	The nominal control voltage value is midway between the minimum and maximum. Voltage control should not exceed the supply voltage +0.2V or GND. Supply voltage $\leq 2.3V$.	0.3 to 1.5	V
4.2	Control voltage range Mode 2	The nominal control voltage value is midway between the minimum and maximum. Voltage control should not exceed the supply voltage +0.2V or GND. Supply voltage $> 2.3V$.	0.4 to 2.4	V
4.3	Frequency control range	Frequency shift from minimum to maximum control voltage	6 to 30	ppm
4.4	Linearity	Deviation from straight line curve fit	10 max	%
4.5	Control voltage input resistance		500	k Ω

5.0 OSCILLATOR OUTPUT

Line	Parameter	Test Condition	Value	Unit
5.1	Output waveform	DC coupled clipped sine-wave (Note 4)		
5.2	Output voltage level	At minimum supply voltage (Note 3)	0.8 min	V
5.3	Output load resistance	Nominal load of 10k Ω	9 to 11	k Ω
5.4	Output load capacitance	Nominal load of 10pF	9 to 11	pF

6.0 POWER DOWN MODE (Enable/Disable Pin) - OPTION

Line	Parameter	Test Condition	Value	Unit
6.1	Power down	RF disabled. Minimum GND	20 max	%Vcc
6.2	Normal operating mode	RF enabled. Maximum Vcc	80 min	%Vcc
6.3	Stand-by current	Typical value $< 0.01\mu A$	2 max	μA
6.4	Start up time (amplitude)	Within 90% of specified output level	0.5 max	ms
6.5	Start up time (frequency)	Within $\pm 0.5ppm$ of steady state	2 max	ms

7.0 SSB PHASE NOISE

Line	Parameter	Test Condition	Value	Unit
7.1	SSB phase noise power density at 1Hz offset	Typical value for a 26.0MHz oscillator at 25°C	-62	dBc/Hz
7.2	SSB phase noise power density at 10Hz offset	Typical value for a 26.0MHz oscillator at 25°C	-90	dBc/Hz
7.3	SSB phase noise power density at 100Hz offset	Typical value for a 26.0MHz oscillator at 25°C	-112	dBc/Hz
7.4	SSB phase noise power density at 1kHz offset	Typical value for a 26.0MHz oscillator at 25°C	-132	dBc/Hz
7.5	SSB phase noise power density at 10kHz offset	Typical value for a 26.0MHz oscillator at 25°C	-145	dBc/Hz
7.6	SSB phase noise power density at 100kHz offset	Typical value for a 26.0MHz oscillator at 25°C	-147	dBc/Hz

8.0 ENVIRONMENTAL

Line	Parameter	Description
8.1	Shock	Half sine-wave acceleration of 3000g peak amplitude. Duration: 0.3ms, Velocity: 12.3ft/s [MIL-STD-202 M213] (Note 5)
8.2	Moisture resistance	1000 hours at 85°C, 85% relative humidity. Biased. [MIL-STD-202 M106g] (Note 5)
8.3	Thermal cycling	1000 temperature cycles, where each cycle consists of a 25 minutes soak time at -40°C followed by a 25 minute soak time at 85°C, with a 60 second maximum transition time between temperatures. Air to air transition. [JESD22 METHOD JA-104C] (Note 5)
8.4	Vibration	10g peak acceleration for 20 minutes. 12 cycles in each of 3 orientations. Test from 10-2000Hz [JESD22-B103-B] (Note 5)
8.5	Storage temperature	-40 to 85°C

9.0 MARKING

Line	Parameter	Description
9.1	Type	Engraved
9.2	Line 1	R code, product code and date code
9.3	Line 2	Pin 1 and internal code

10.0 MANUFACTURING INFORMATION

Line	Parameter	Description
10.1	Reflow	Solder reflow processes as per profile attached
10.2	Packaging description	Tape and reel. Standard packing quantity is 4000 per reel

11.0 SPECIFICATION NOTES

Line	Parameter	Description
11.1	Note 1	Parts should be shielded from drafts causing unexpected thermal gradients. Temperature changes due to ambient air currents on the oscillator can lead to short term frequency drift
11.2	Note 2	The operating temperature range needs to be specified. The extremes for this model are -40 to 85°C
11.3	Note 3	Specified for load stated in 5.3 and 5.4 at 25°C
11.4	Note 4	External AC-Coupling capacitor required. 1nF or greater recommended
11.5	Note 5	Frequency shift ≤1ppm after environmental conditions

Drawing Name: I(V)T2100F Model Drawing

MODEL DRAWING

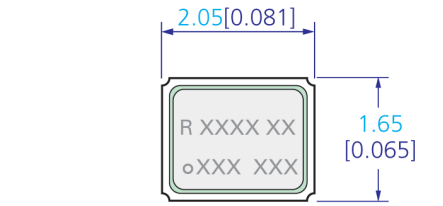

TOP VIEW

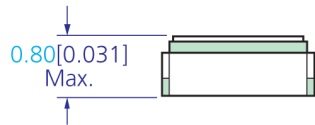

SIDE VIEW

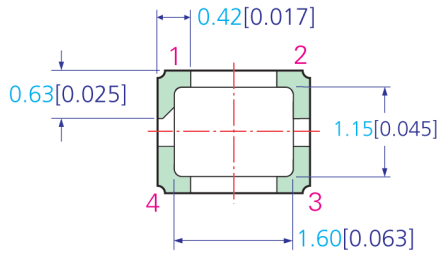

BOTTOM VIEW

LID MARKING

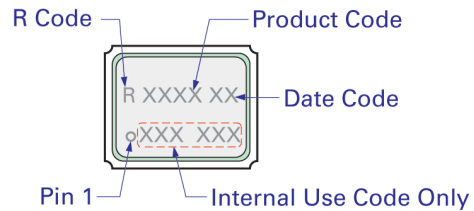

PIN CONNECTION

PIN	IT21..F	IVT21..F	IT21..FP
1	GND / NC	VCO	Enable / <u>Disable</u>
2	GND	GND	GND
3	OUTPUT	OUTPUT	OUTPUT
4	VCC	VCC	VCC

RECOMMENDED PAD LAYOUT - TOP VIEW

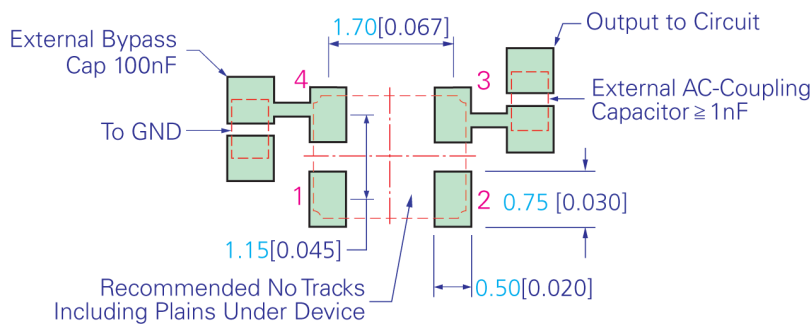

TITLE: I(V)T2100F SERIES MODEL

RELATED DRAWINGS:

PRELIMINARY

FILENAME: CAT567

REVISION: D

DATE: 05-Apr-11

SCALE: 10 : 1

Millimeters [inch]

Tolerance:

XX = ±0.5

X.X = ±0.2

X.XX = ±0.10

X.XXX = ±0.05

X° = ±1.0°

Hole = ±0.10



©2009 Rakon Limited

Drawing Name: I(V)T2100F Series Test Circuit

IT21..F TEST CIRCUIT :

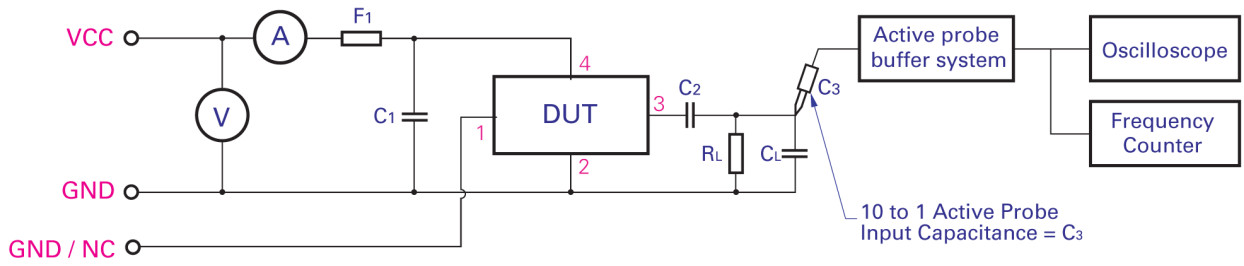

IVT21..F TEST CIRCUIT :

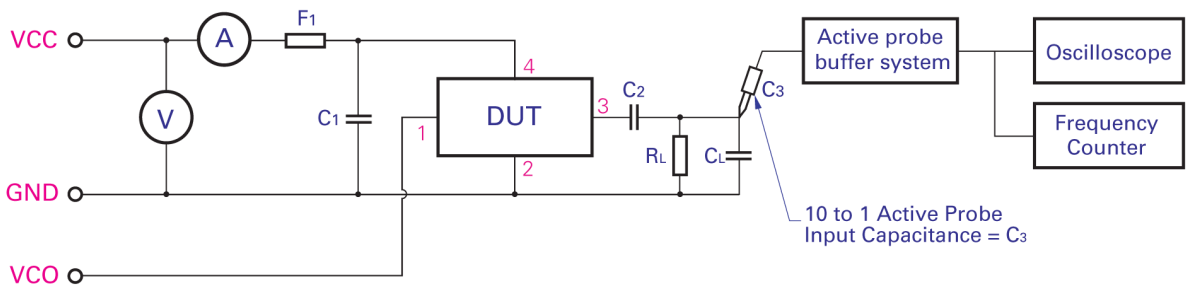

IT21..FP TEST CIRCUIT :

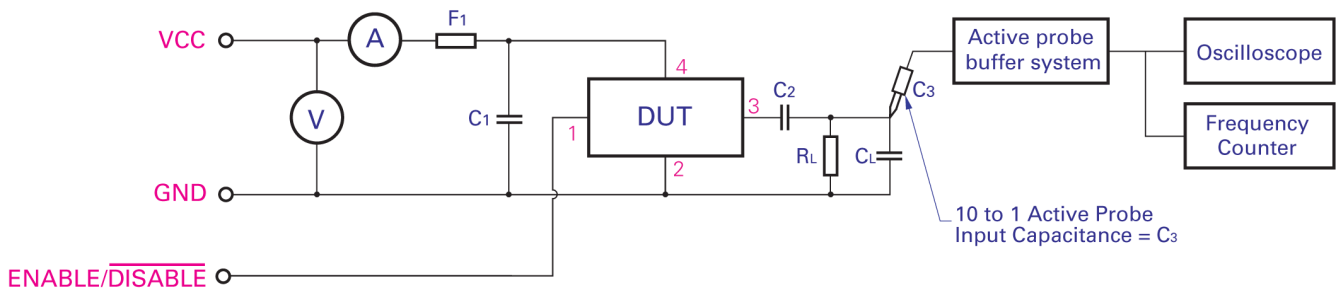

C1: 100nF	$C_T = C_L + C_3$ (C_3 - Oscilloscope probe capacitance) C_T as stated in OSCILLATOR OUTPUT section F1: A ferrite bead or a resistor between $22\Omega \sim 47\Omega$ recommended.
C2: $\geq 1nF$	
RL: 10K	

TITLE: I(V)T2100F SERIES TEST CIRCUIT

FILENAME: CAT577

RELATED DRAWINGS:

REVISION: A

DATE: 22-Feb-11

SCALE: NTS

Millimetres [inch]



©2009 Rakon Limited

Drawing Name: 2100 Series Tape & Reel

TAPE DETAIL (SCALE 5 : 1)

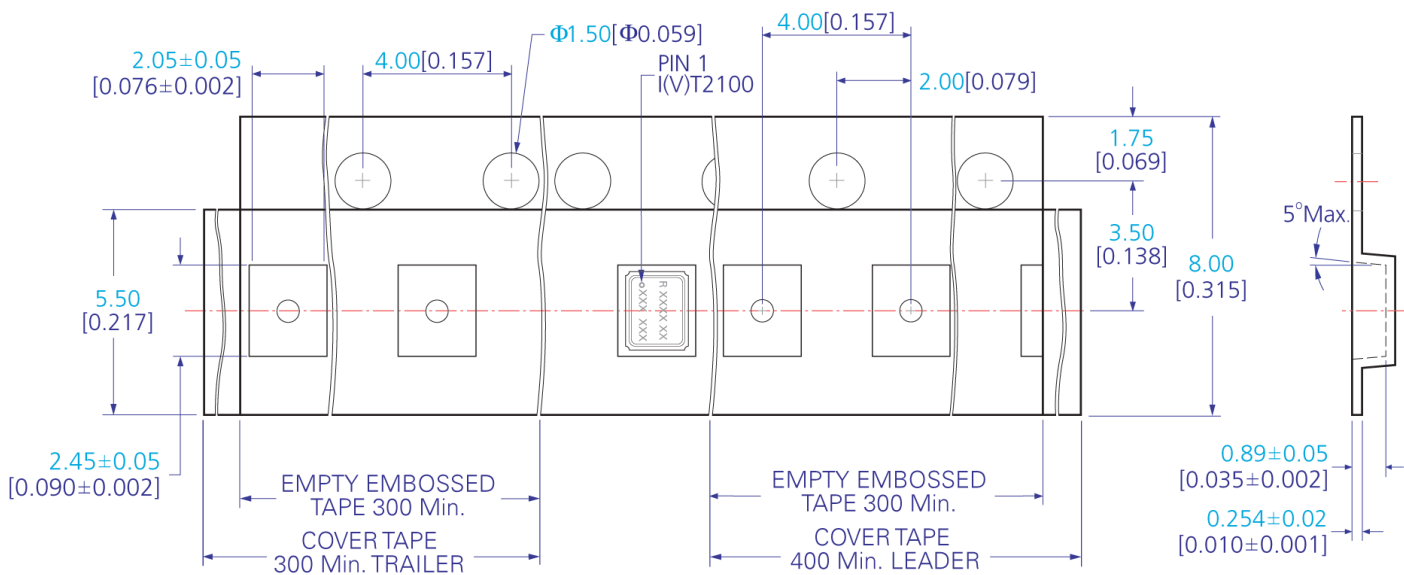

REEL DETAIL (SCALE 1 : 2.5)

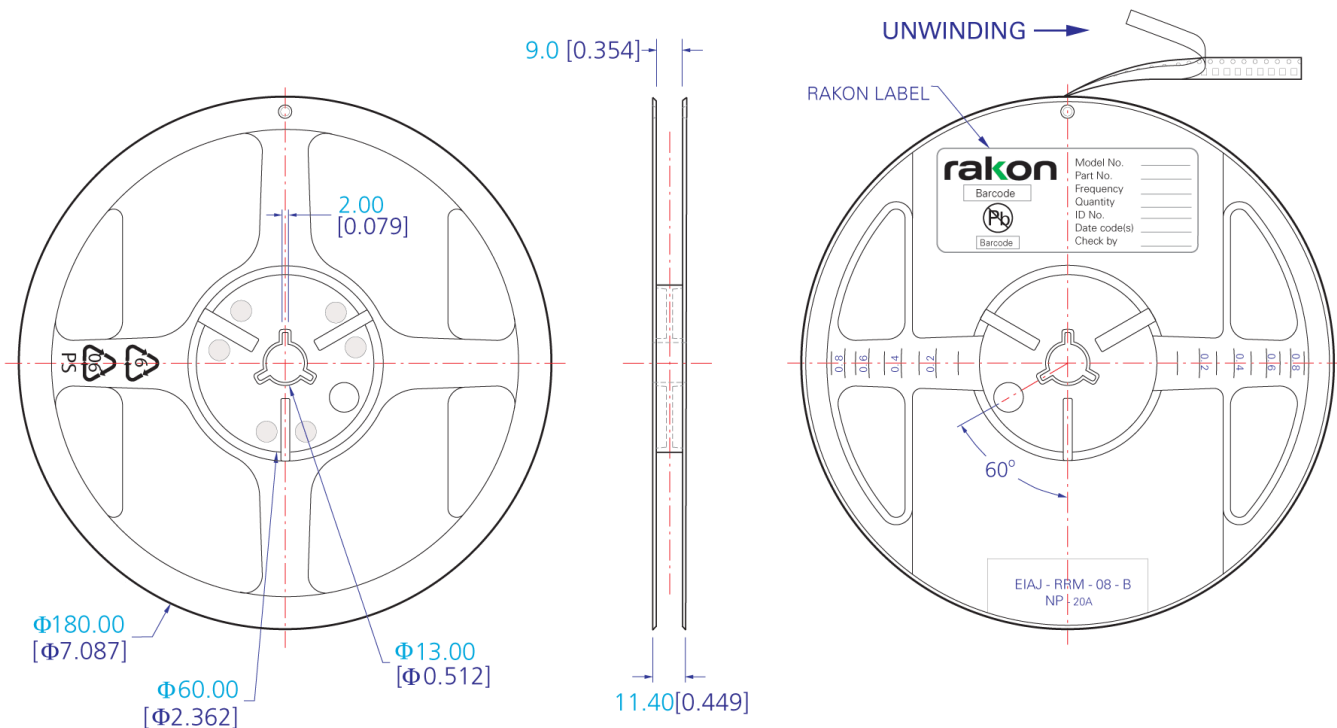

TITLE: 2100 SERIES TAPE & REEL

RELATED DRAWINGS:

FILENAME: CAT461

REVISION: D

DATE: 15-Mar-11

SCALE: See Above

Millimetres [inch]

Tolerance:

XX = ±0.5

X.X = ±0.2

X.XX = ±0.10

X.XXX = ±0.05

X° = ±1.0°

Hole = ±0.10

rakon

©2009 Rakon Limited

Drawing Name: Pb-Free Reflow

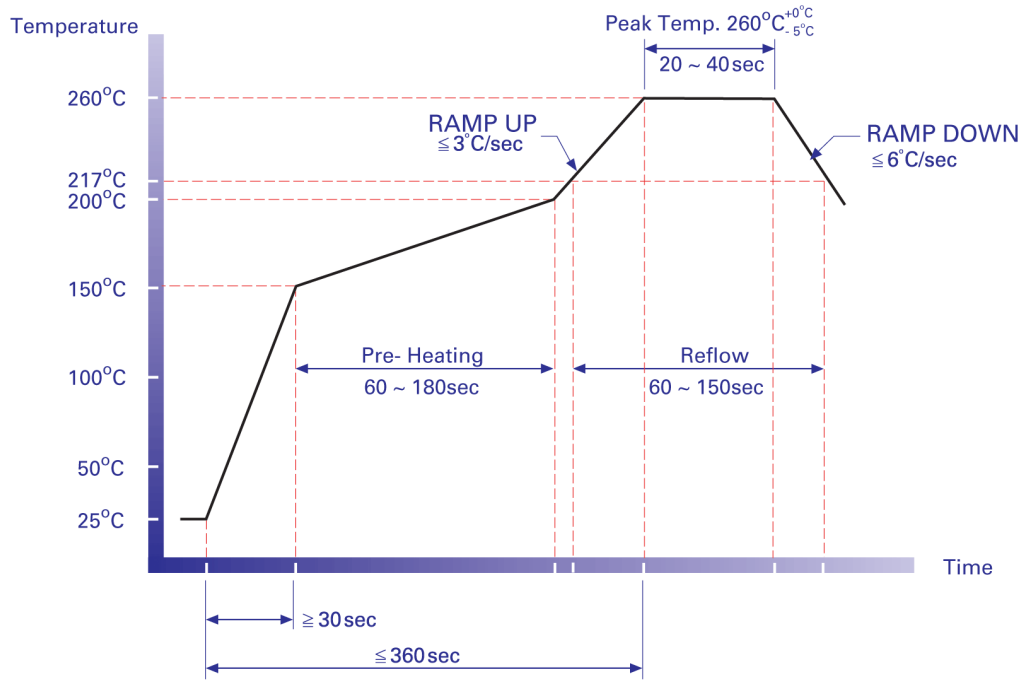

NOTE:

The product has been tested to withstand the Reflow Profile shown. The Reflow Profile used to solder Rakon products is determined by the solder paste manufacturer's specification. It is recommended that the Reflow Profile used does not exceed the one shown above.

TITLE: Pb-FREE REFLOW

RELATED DRAWINGS:

FILENAME: CAT541

REVISION: B

DATE: 07-Apr-10

SCALE: NTS

Millimetres [inch]



©2009 Rakon Limited